



Product guide

# moll unique

moll unique - design desks and swivel chairs, mobile containers, desk lights and accessories create an outstanding unique feeling - while sitting or standing.

# moll unique

## Truly intuitive and exceptionally chic.

Reaching a higher level with modern design and self-explanatory functions: Whether in your home office or in your own office, our unique collection combines high-quality materials, elegance, movement and function. The well-engineered moll workspace concepts pursue two goals at the same time. Goal number one: outstanding materials and manufacturing quality, the highest possible variability and optimal ergonomics combined with maximum comfort for undisturbed and focused work. Objective number two is to create a unique design that merges desk and swivel chair into a single unit within your home and sets elegant and simple accents in the room.

## unique: "The all-inclusive island of well-being"

unique is the composition of high-quality furniture full of changeable, well designed details. Beginning with the mechanically adjustable T5: a powerful performer with a patented spring mechanism that ensures that the desk can be moved from sitting to standing height within a heartbeat. For the T7 and T7 exclusive it's the electric motor power within the desk that controls the height. To put unique in a nutshell: It's first-class design, high-quality materials and flawless workmanship. The same applies to our swivel chairs: S6 and S9 bring extra comfort and color to the workplace. While working at the desk, the Flexlight or L7 provide the ideal light. The workplace concepts are complemented by a comprehensive range of universal accessories. Together, our masterpieces bring a first-class interior character to your home.

Your expert for functional  
and ergonomic study and office furniture

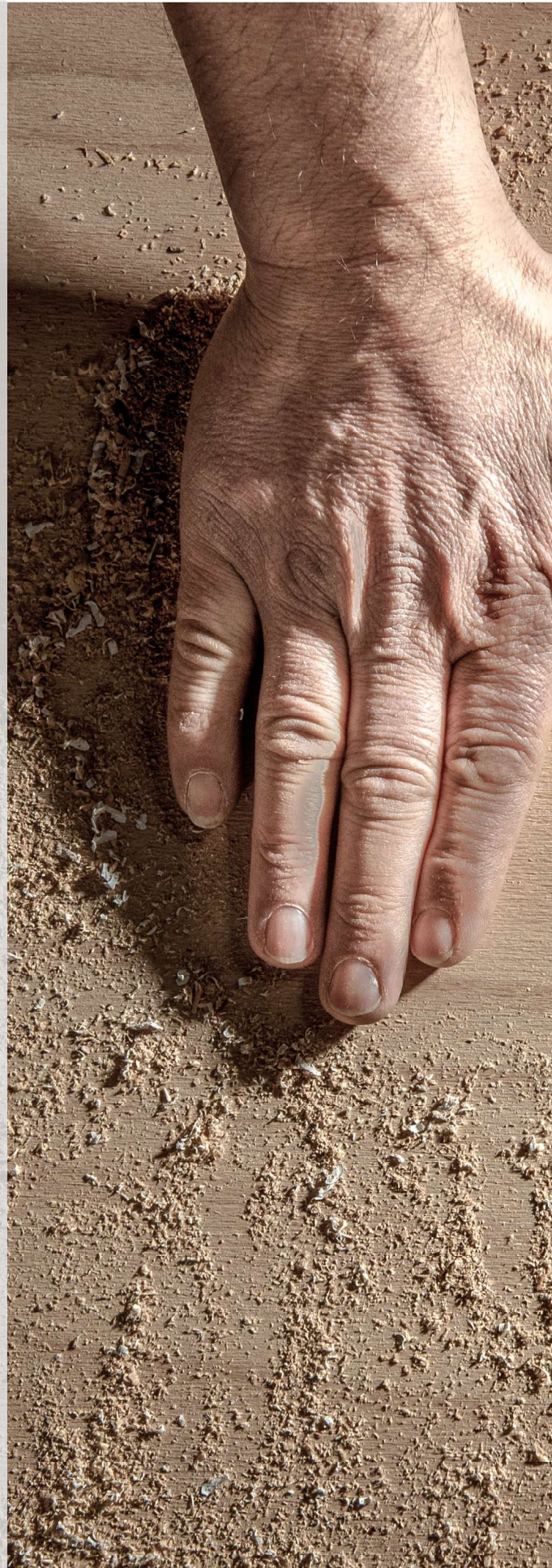



## Content

4	Height adjustments by moll
6	Surface of the unique desks
7	Tilting of the T5 desktop
	<b>unique desks</b>
8	moll T5
16	moll T7
	<b>unique mobile container</b>
22	moll C7
	<b>Swivel chairs</b>
26	moll S6
28	moll S9
	<b>Desk lights</b>
32	Flexlight
34	moll L7
36	Fabrics
39	Materials
40	Certificates

# Height adjustments by moll



- » Adjustment system: electromotive
- » Stepless height adjustment
- » Collision prevention
- » Detachable key
- » Can be set for one-hand operation or two-hand operation
- » Adjustment range: 56 - 118 cm
- » Adjustment range with height adapter: 66 - 128 cm
- » Body height: 1.25 - 2.00 m



## Electromotive height adjustment

Lift up at the touch of a button for maximum comfort. That's the electromotive height adjustment, which is the base of our modern T7. The desk is effortlessly transformed from a sitting to a standing desk by an integrated motor and thus always guarantees the right working height. With an adjustment range from 56 to 118 cm, the desk can also be converted into an inviting couch or side table. The optional height adapter adds another 10 cm to the adjustment range. A cable ensures the electrical connection and is also the power supply for the socket strip integrated into the desk. The height adjustment also has collision protection and stops in the event of hard resistance.



**The following chart is a guide for adjusting the desk height. Please ensure that the chair is set up correctly while sitting.**

Body height	Desk height while sitting	Desk height while standing
127 cm	~ 56 cm	~ 80 cm
135 cm	~ 59 cm	~ 85 cm
143 cm	~ 63 cm	~ 90 cm
151 cm	~ 66 cm	~ 96 cm
159 cm	~ 69 cm	~ 102 cm
167 cm	~ 72 cm	~ 108 cm
175 cm	~ 75 cm	~ 113 cm
183 cm	~ 79 cm	~ 118 cm
191 cm	~ 82 cm	~ 124 cm
200 cm	~ 85 cm	~ 128 cm



## Mechanical height adjustment

Fast, faster, T5 - in less than a second from sitting to standing desk. Without electricity or physical effort, just by using the operating lever, the desk can be moved from sitting to standing height within unbeatable 0.8 seconds. The quiet express height adjustment offers a wide height range from 69 to 114 cm. The spring force of the desk can be adjusted according to the desk load. As an option, the height adapter can be used to increase the adjustment range by additional ten centimeters - from 79 to 124 cm.

- » Adjustment method: spring mechanism
- » Adjustment range: 69 - 114 cm
- » Adjustment range with height adapter: 79 - 124 cm
- » Body height: 1.55 - 1.95 m

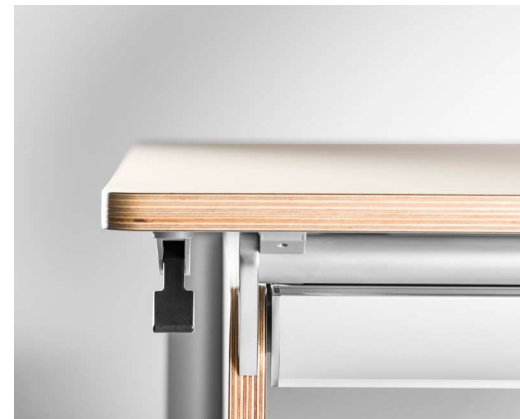

**The following chart is a guide for adjusting the desk height. Please ensure that the chair is set up correctly while sitting.**

Body height	Desk height while sitting	Desk height while standing
127 cm	~ 56 cm	~ 80 cm
135 cm	~ 59 cm	~ 85 cm
143 cm	~ 63 cm	~ 90 cm
151 cm	~ 66 cm	~ 96 cm
159 cm	~ 69 cm	~ 102 cm
183 cm	~ 79 cm	~ 118 cm
191 cm	~ 82 cm	~ 124 cm

# Surfaces of the unique desks

## Preciously combined or velvety smooth

Made of high-quality materials and perfectly manufactured, the T7 proves its adaptability in your office or home office in a stylish way and facilitates desk work with ingenious functions. Whether in plain white, with colorful panels or an elegant solid wood desktop in walnut or oak veneer - the T7 is a masterpiece. The easy-to-clean surface of the T7 is robust and its matt structure prevents disturbing reflections on the work surface. The solid wood desktop of the T7 exclusive, provides both a warm desk surface and a pleasant feel, besides its noble and natural appearance.

The T5 is also made of unique materials: desktop and side panels are made of a stable birch multiplex board, which is coated with a "nano high-tech" surface that provides a particularly soft and velvety feel. Therefore also its matt look: No fingerprints are left behind on this surface. It is also antibacterial and hygienic, antistatic and water-repellent, abrasion and especially scratch-resistant. And naturally it is easy to clean.



### Materials:

#### moll T7 collection:

- Basic model with white melamine coated MDF board
- Exclusive oak/walnut model made of veneered solid wood panels sealed with water-based UV lacquer
- Panel in white/lilac/light blue are made of lacquered moulded plywood
- Panel in oak/walnut formed plywood with oiled real wood surface

#### moll T5:

- Made of multiplex board and coated with nano soft-touch

# Tilting of the T5 desktop

## It was meant to be versatile

The tiltable desktop of the T5 supports an ergonomic posture during desk work. This prevents users of the desk from leaning too far forward or adopting a bad posture. Possible pain in the neck or a potentially incorrect posture will be prevented in this way.

A simple, intuitive rope pull system is integrated under the front edge of the desk, allowing the user to adjust the desktop intuitively at any time during desk work. It does not only look good, but can also be operated while sitting or standing. The desktop can be tilted up to 20 degrees very easily and safely.

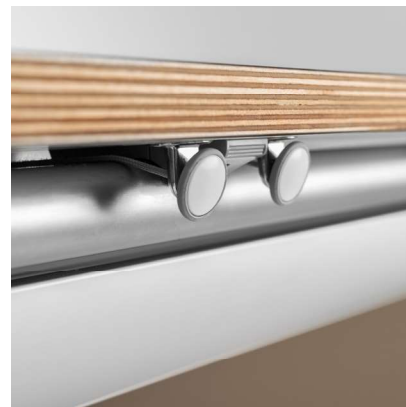

### T5 rope pull system:

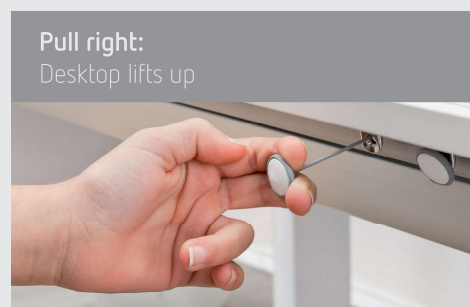

or

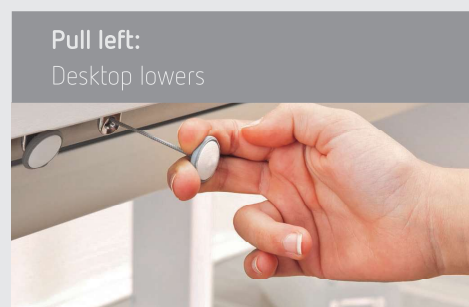

# moll T5







# moll T5



Design: Martin Moll





## Features:

Desktop and additions	Desktop	Width (cm)	Depth (cm)	Height (cm)	Design
T5	split	90	72	69-114	beige
Height adapter	-	-	-	+10	-

- A** The tiltable desktop with comfortable rope pull system optimises an ergonomic posture.
- B** The desktop and side panels are made of birch multiplex and have a nano soft-touch surface as well as oiled edges.
- C** Available with the **express** height adjustment (69-114 cm) for a body height of 1.55 to 1.95 meters. With the height adapter the T5 adds another 10 cm (79-124 cm).

The T5 preload can be adjusted according to the load added (up 35 kg), so that no force is required to adjust the height.

- D** The aluminium cable duct is located at the back of the table.
- E** The footbase is equipped with castors in the rear part so that the desk can be easily moved.

### Additions:

- F** Drawer and drawer cover
- Wireless Qi Charger
- G** Cable duct cover
- H** E1 (esk side extension)
- I** E2 (built-on desk shelf)
- Height adapter (+10 cm)

# moll T5

- ↔ 90 cm
- ↔ 72 cm
- ↔ 69-114 cm (with height adapter 79-124 cm)
- ⊕ 49 kg
- ⊞ 0,58 m<sup>3</sup>
- ⊞ 1



**05 Desktop version**



moll T5



■ 90 x 19 cm ■ 90 x 53 cm

**Legs**



**express** legs - stepless and quick height adjustment, the desk height is adjustable from 69 to 114 cm and with the height adapter from 79 to 124 cm for a body height of 1.55 to 1.95 m.





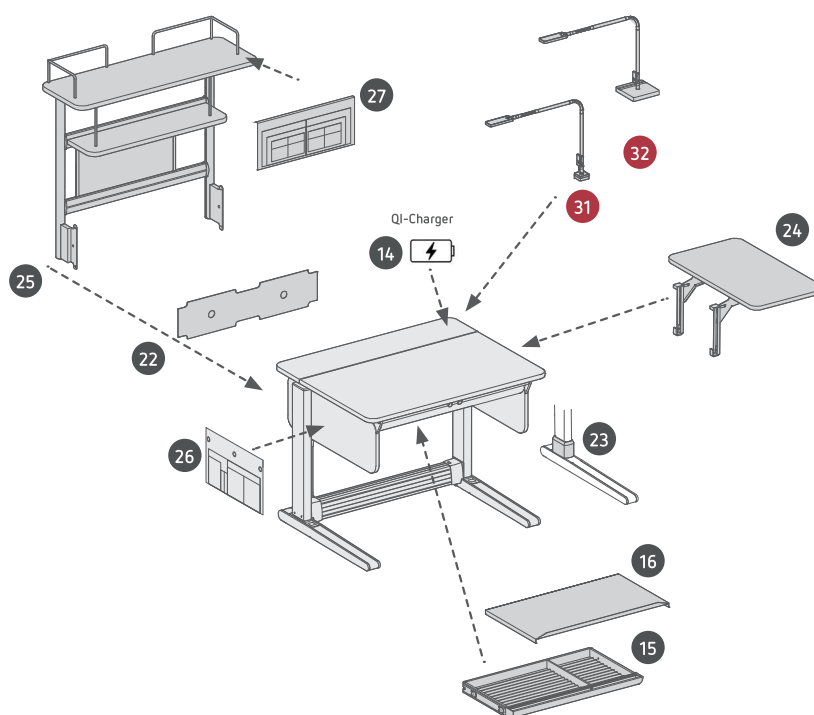

The power pack: In no time at all, the moll T5 can be adjusted to the perfect standing or sitting height - ideal for a body height of 1.55 to 1.95 metres. The desktop, which can be tilted up to 20 degrees, also optimises the ergonomic posture. An additional highlight is the "Nano-Hightech" coated surface of the desk, for a particularly smooth feel.

Further information about additions:

- moll T5 additions (p. 13-15)



## Additions:

- 17 
- 18 
- 19 
- 20 
- 21 
- 28 

## 14 Qi-Charger

- ↔ 8 cm
- ↕ 8 cm
- ⬆ 0,3 kg
- 📦 0,002 m<sup>3</sup>
- 🔧 1



- Integrated into the desktop (not visible)
- Wireless charging of smartphones & -watches
- Charging position for the device is indicated by a small sticker on the desktop
- See [www.moll-funktion.com](http://www.moll-funktion.com) for compatible devices

## 15 Drawer

- ↔ 103 cm
- ↕ 42 cm
- ↔ 5,5 cm
- ⬆ 4,3 kg
- 📦 0,03 m<sup>3</sup>
- 🔧 1



- Aluminium colored drawer - load capacity up to 6 kg
- Partitioned by crossbars in two sections
- Size of the drawer: one DIN A3 and one DIN A4 compartment
- Plenty of storage space without limiting the space to move
- 2 foam inlays prevent the content from slipping
- Can be retrofitted
- Additions: Orga-Set and drawer cover

## 24 E1

- ↔ 40 cm
- ↕ 72 cm
- ⬆ 7,5 kg
- 📦 0,04 m<sup>3</sup>
- 🔧 1



- Desk extension in width - load capacity up to 12 kg
- Horizontal side shelf with rounded corners, also with tilted desktop
- Height can be adjusted in two steps
- Can be mounted on the right or left side (possible on both sides)
- Fixed by using two brackets on the table side
- Material: birch multiplex with oiled edges
- Can be retrofitted
- Addition: moll Baskets

## 25 E2

- ↔ 86 cm
- ↕ 30 cm
- ↔ 63 cm
- ⬆ 13,5 kg
- 📦 0,09 m<sup>3</sup>
- 🔧 1



- Multifunctional wall with two shelves and one magnetic board / whiteboard incl. 4 magnets - load capacity up to 12 kg
- Additional shelf space above the desktop
- Rounded shelves
- Two aluminium corner brackets on the top shelf (lateral support)
- Fixed by using two brackets on the back of the desk
- Material: birch multiplex with oiled edges
- Can be retrofitted
- Additions: Utensilo behind and moll Baskets

## 16 Drawer cover

↔ 104 cm  
↗ 42 cm  
↕ 4 cm  
📦 2,2 kg  
📏 0,02 m<sup>3</sup>  
🗄️ 1



- Aluminium colored cover
- Drawer cover prevents the contents from getting dusty and provides visual protection, especially when the desktop is tilted
- Material: High quality and lightweight aluminium compound

## 17 Design ruler

↔ 54 cm  
↗ 5 cm  
↕ 1 cm  
📦 0,7 kg  
📏 0,008 m<sup>3</sup>  
🗄️ 1



- High quality aluminium ruler
- 2 invisible magnetic inlays keep the anti-slip device at the desktop when the T5 is tilted

## 18 Cable-Butler

↔ 10 cm  
↗ 5 cm  
↕ 8 cm  
📦 0,2 kg



- Handy tool for all notebook or desktop users
- Can be clamped to the desktop of the T5
- Ensures that all cables are secured and organized on the desk
- Cables remain within reach and are prevented from falling down

## 19 Design book holder

↔ 33 cm  
↗ 13 cm  
↕ 24 cm  
📦 0,6 kg  
📏 0,001 m<sup>3</sup>  
🗄️ 1



- "High End" book holder which can be folded up
- Two flip-out brackets keep the book open
- Brackets allow the book holder to be hooked in even when the desktop is tilted.

## 20 Orga-Set

↔ 23 cm  
↗ 17 cm  
↕ 5 cm  
📦 0,4 kg



- Fits into all moll drawers and mobile containers
- Writing utensils are neatly stored in the drawer and can be placed on the desk as a complete set
- With flip-out tape dispenser and sharpener

## 21 Hook for bags

↔ 5 cm  
↗ 3 cm  
↕ 5 cm  
📦 0,18 kg



- For hanging on the right or left side panel of the T5 - so the bag always remains in place

## 22 Cable duct cover

↔ 72 cm  
✂ 16 cm  
⚖ 0,6 kg  
📦 0,002 m<sup>3</sup>  
📦 1



- Translucent cover covers the cable duct
- Protects the cable duct from dust

## 23 Height adapter Express

↕ 10 cm  
⚖ 1,6 kg  
📦 0,01 m<sup>3</sup>  
📦 1



- Increases the desk height by additional 10 cm for a body height of 1.85 meters and above
- Height adjustment range from 79 to 124 cm (instead of 69-114 cm)

## 26 Utensilo beside

↔ 41 cm  
✂ 2 cm  
↕ 24 cm  
⚖ 0,7 kg



- Useful organisational tool
- Mounted on the sides of the T5
- With pockets of different sizes
- Available in four colors: blue, grey, green, pink
- Material: hard-wearing polyester
- Load capacity up to 2.5 kg

## 27 Utensilo behind

↔ 48 cm  
✂ 2 cm  
↕ 23 cm  
⚖ 1,1 kg



- Useful organisational tool
- Matching E2
- With pockets of different sizes
- Available in four colors: blue, grey, green, pink
- Material: hard-wearing polyester
- Load capacity up to 2.5 kg

## 28 moll Baskets

↔ 20,6 cm  
✂ 17,8 cm  
↕ 13,2 cm

**Basket 130**



↔ 28,6 cm  
✂ 20,6 cm  
↕ 6,8 cm

**Basket 70**



- Each set consists of one Basket 130 and one Basket 70
- The felt boxes have practical grip loops
- Office accessories can be neatly stowed away
- Available in four colors: blue, grey, green, pink (inside grey)

# moll T7







# moll T7



Design: Martin Moll



reddot design award  
winner 2016



## Features:

Desk models and additions	Width (cm)	Depth (cm)	Height (cm)	Desktop design	Panel design	Legs
T7	115	75	56-118	white	white, light blue, lilac, oak, walnut	white
T7 exclusive	115	75	56-118	oak, walnut	white, black	white, black
T7 XL	150	75	56-118	white	white, light blue, lilac, oak, walnut	white
T7 exclusive XL	150	75	56-118	oak, walnut	white, black	white, black
Height adapter	-	-	+10	-	-	white, black

### Material of the desktop:

T7: Melamine coated MDF board in white

T7 exclusive: Lacquered solid wood desktop veneered in walnut or oak

### Material of the panels:

Optionally in 3 different lacquer colors (see details above) or two real wood versions (walnut/oak)

- A** Design desk with electromotive height adjustment. The power supply of the desk including the socket strip is fed by only one cable. In addition, the minimum and maximum desk height can be preset using the integrated container- or shelf- stop-position.

One-hand or two-hand (standard at delivery) operation can be set. The electromotive height adjustment can also be deactivated completely with a removable key.

- B** The integrated power management (socket strip) in the rear part of the desk offers 6 sockets and sufficient storage space for cables, so that they can be stored completely invisible.
- C** The built-in drawer with individual compartments and pencil tray offers plenty of space for keeping things tidy.
- D** The runners are equipped with castors in the rear part so that the desk can be easily changed in position.

### Additions:

- E** Wireless Qi-Charger  
 Height adapter (+10 cm)  
 Design matching mobile container C7

# moll T7

- ↔ 115 cm (T7 XL: 150 cm)
- ↔ 75 cm
- ↔ 56-118 cm (with height adapter 66-128 cm)
- ⊕ 54,2 kg (T7 XL: 67,2 kg)
- ⊞ 0,61 m³ (T7 XL: 0,72 m³)
- 🗑 1



Whether desktop, office desk, coffee table or standing desk the moll T7 is ready for all situations. Uniquely variable from 56 - 118 cm due to its electromotive height adjustment. And yet perfectly reduced: to first-class design, high-quality materials and flawless workmanship. Interchangeable color and real wood panels make the T7 a lifelong design icon.

01 02

## moll T7 desk and panel design

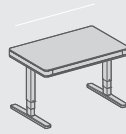

T7

T7 XL



■ 115 x 75 cm

■ 150 x 75 cm

### Select panel design:

white, light blue, lilac, oak, walnut

### Select the color of the legs:

white

**motor** Legs – electromotive height adjustment, desk height adjustable from 56 to 118 cm (or 66 - 128 cm), suitable for a body height of 1.25 to 2.00 meters.

03 04

## moll T7 exclusive desk and panel design

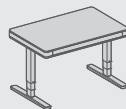

T7 exclusive

T7 XL exclusive



■ 115 x 75 cm

■ 150 x 75 cm

### Select panel design:

white or black

### Select desktop design:

oak or walnut

### Select the color of the legs:

white or black

**motor** Legs – electromotive height adjustment, desk height adjustable from 56 to 118 cm (or 66 - 128 cm), suitable for a body height of 1.25 to 2.00 meters.

Further information about additions:

- moll T7 additions (p. 14 and 21)

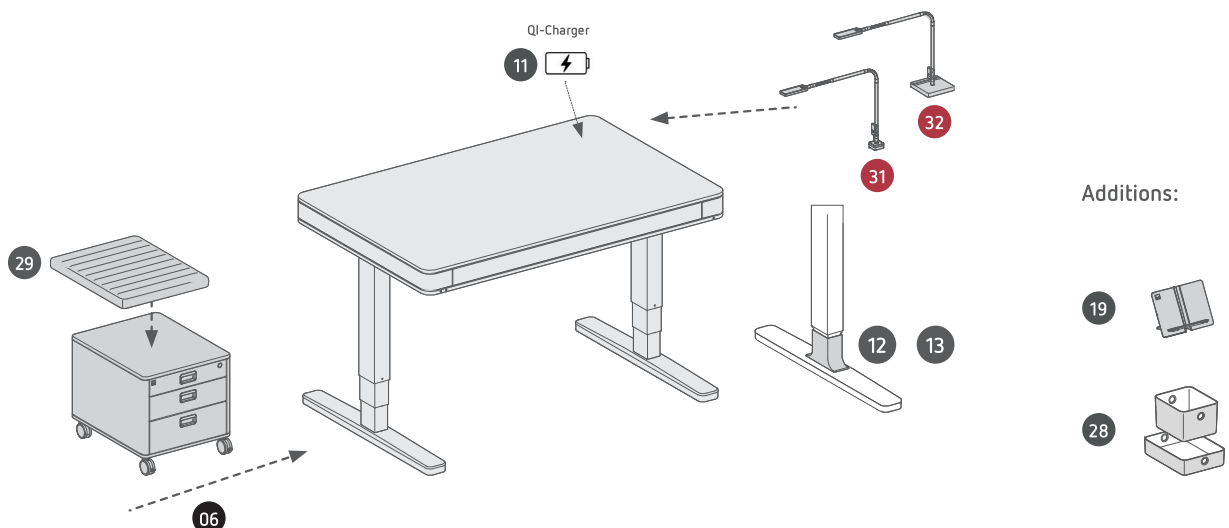

Additions:

Please select the appropriate part number according to the country of destination when ordering the following mounted equipment:

- 09 Multiple socket F/E/G/I/J
- 10 Power cord F/E/G/I/J
- 11 T7 Qi-Charger F/E/I/J

Country	F	E	G	I	J
	AT, BA, BG, BY, DE, DK, EE, ES, FI, GR, HR, HU, KR, LT, LU, LV, MD, ME, NL, NO, PT, RO, RS, RU, SE, SI, TR, UA	BE, CZ, DK, FR, PL, SK	CY, GB, HK, IM, IE, MT	CN	CH, LI

### 11 T7 Qi-Charger

- ↔ 8 cm
- ↔ 8 cm
- ⊞ 0,3 kg
- 📦 0,002 m<sup>3</sup>
- 📦 1



- Invisible integrated into the desktop
- Wireless charging of smartphones & -watches
- Charging position for the device is indicated by a sticker on the desktop
- See [www.moll-funktion.com](http://www.moll-funktion.com) for compatible devices

### 12 13 Height adapter

- ↕ 10 cm
- ⊞ 1,6 kg
- 📦 0,01 m<sup>3</sup>
- 📦 1



- Desk extension by another 10 cm for a body height of 2.00 meters and more
- With the height adapter the moll T7 has a different height adjustment range from 66 to 128 cm (instead of 56-118 cm)

### 06 C7

- ↔ 43 cm
- ↔ 54 cm
- ↕ 42 cm
- ⊞ 25,6 kg
- 📦 0,13 m<sup>3</sup>
- 📦 1



- Mobile container with rounded corners - load capacity up to 75 kg
- Four castors - two are with brakes
- Two drawers (DIN A3) - load capacity up to 2.5 kg
- One lockable equipment drawer with a hidden secret box – can be loaded up to 1 kg
- Automatic self-closing system
- Material: melamine-coated particle board
- White body - white, colored or veneered drawer front panels
- Addition: (Seat-) pad – turning the C7 into a stool

### 29 Pad

- ↔ 44 cm
- ↔ 54 cm
- ↕ 7 cm
- ⊞ 3,5 kg
- 📦 0,02 m<sup>3</sup>
- 📦 1



- (Seat) pad for C7 - anti-slip strips hold the Pad securely in place
- Fabric cover is available in many different colors – these are matched to the upholstery of the chairs
- Comfortable and high-quality 4 cm foam filling
- The cover is easy to clean – always follow the attached care and washing instructions

# moll C7





**Features:**

Mobile container	Width (cm)	Depth (cm)	Height (cm)	Body design	Drawer front design
C7	43	54	42	white	white, light blue, lilac, oak, walnut

**A** The C7 is an excellent match for the T7: The mobile container has 3 drawers (DIN A3) with a self-closing mechanism, one of them is lockable and has a secret compartment.

**Load capacity**

Drawers: 2.5 kg

Drawer for accessories: 1 kg

**B** The body is available in white. The drawer decor panels are available in three T7-design color options and the two real wood versions.

**C** All corners of the C7 are rounded.

**D** Four castors - two are equipped with brakes.

**E** With a Pad, the C7 becomes a stool with a maximum load capacity of 75 kg.

**Addition:**

**H** (Seat-) Pad

# Flexlight

31

- ↔ 62 cm
- ↕ 42 cm
- ⊞ 2 kg
- ⊞ 0,01 m<sup>3</sup>
- ⊞ 1

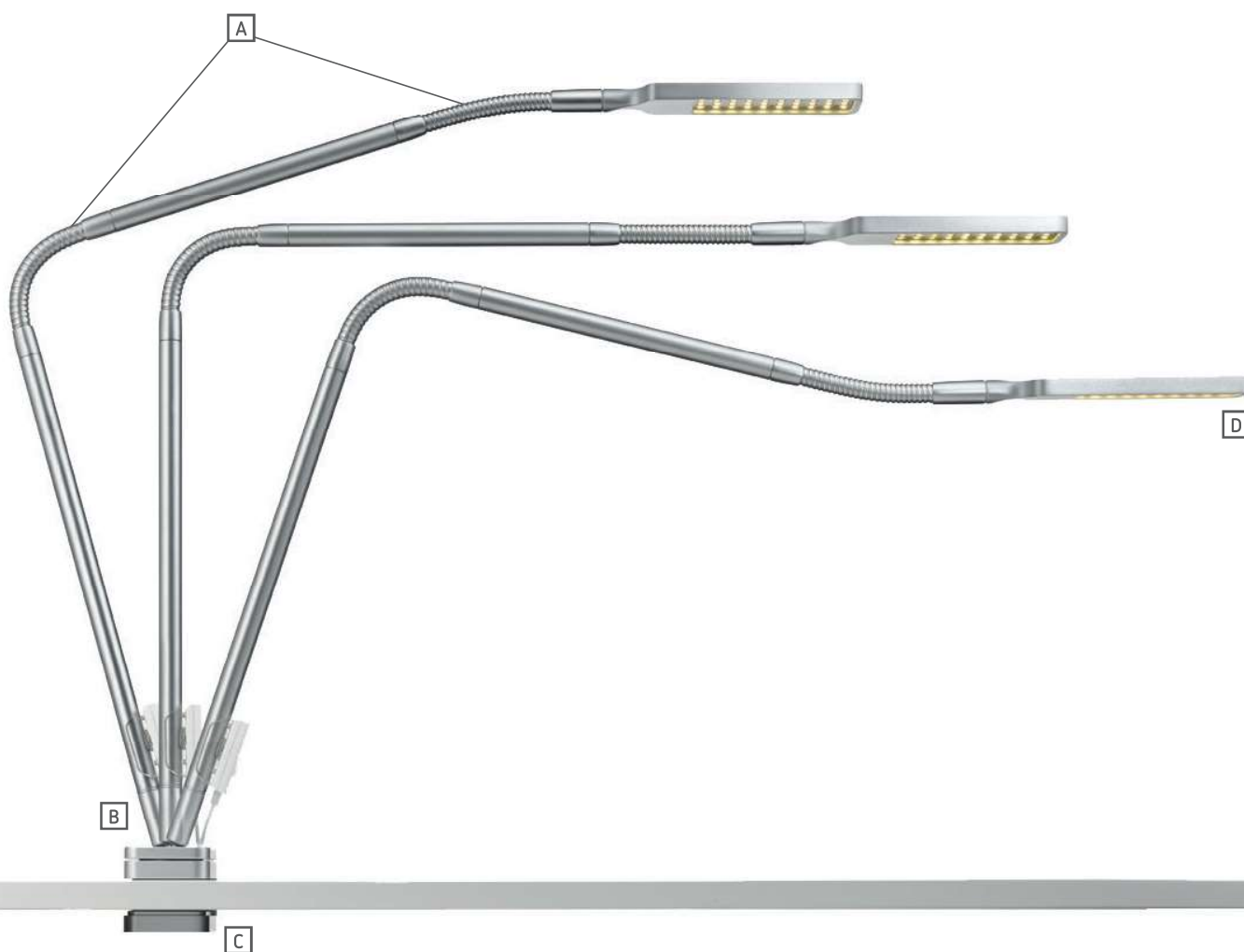

Design: PEARL CREATIVE



2002196/EC-WEEE



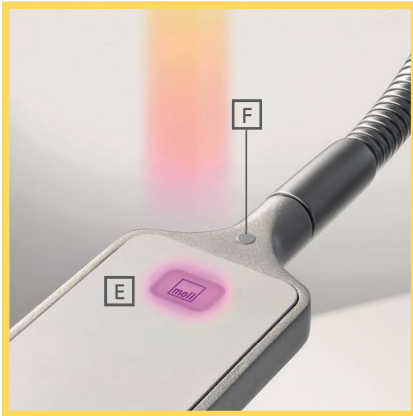
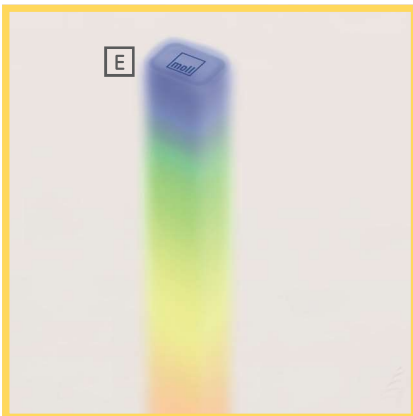

## Features:

Contemporary designed LED desk light with various additional functions to clip onto the desktop.

- A** The Flexlight has two flexible goosenecks which allow maximum versatility in the alignment of the desk light.
- B** The integrated ball joint in the base allows the light to be positioned exactly where it is needed.
- C** A clamp holds the Flexlight securely to the desk - for a desktop thickness from 13 to 23 mm. Unique: this even works perfectly when the light is mounted on a tilted desktop.
- D** Luminaire head with 40 LEDs of energy efficiency class: A - A++
  - » 85 % reduction in energy consumption compared to a 60 W light bulb
  - » Nominal luminous flux 690 lumen
  - » Nominal power consumption 10 W
  - » Color temperature 3500 K
  - » Nominal service life 25,000 h (lamp)
- E** Power button with additional night light function, which can change its color at the touch of the button. If required, this function can be switched off.
- F** Illumination is controlled via a touch button - flicker-free and steplessly dimmable between 100% and 5%.

## Built-in:

- G** USB charger

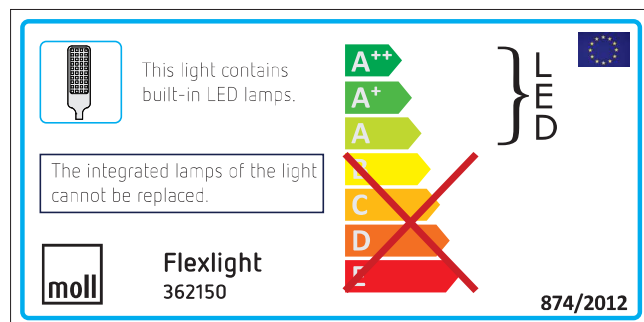

# L7

32

- ↔ 62 cm
- ↕ 42 cm
- ⚖ 4,1 kg
- 📦 0,01 m<sup>3</sup>
- 🔧 1

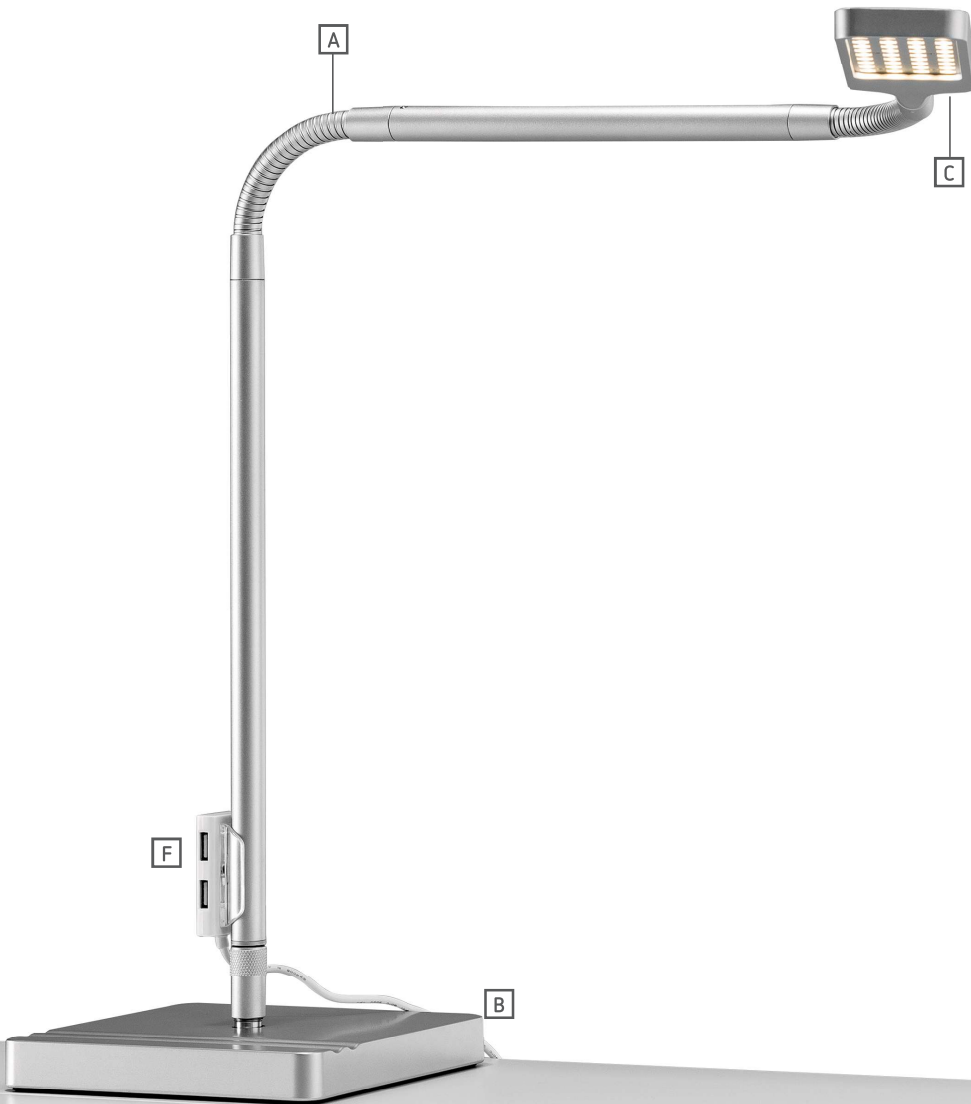

2002196/EC-WEEE

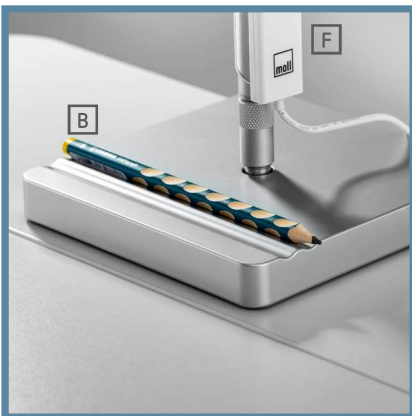
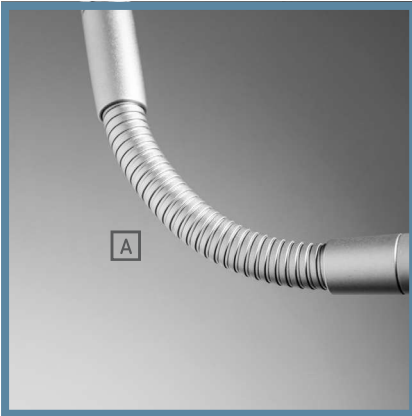

## Features:

Plainly designed LED desk light with base and a wide range of additional functions.

- A** Two goosenecks provide the necessary flexibility.
- B** Due to its weight, the light base provides a safe stand for the L7. Two practical pen trays for writing utensils are integrated.
- C** Luminaire head with 40 LEDs of energy efficiency class: A - A++
  - » 85 % reduction in energy consumption compared to a 60 W light bulb
  - » Nominal luminous flux 690 lumen
  - » Nominal power consumption 10 W
  - » Color temperature 3500 K
  - » Nominal service life 25,000 h (lamp)
- D** Power button with additional night light function, which can change its color at the touch of the button. If required, this function can be switched off.
- E** Illumination is controlled via a touch button – flicker-free and steplessly dimmable between 100% and 5%.

### Built-in:

- G** USB charger





This light contains built-in LED lamps.

The integrated lamps of the light cannot be replaced.



} LED











**moll L7**  
268860

874/2012

# Measurements

## Measurements of the product guide:

- |  |  |
|--|--|
|  Space required in width  |  Weight of the product  |
|  Space required in depth  |  Volume of the packages |
|  Space required in height |  Number of packages     |

# Fabrics

## Composition Uni <sup>1</sup>

- Material: 100% flame-resistant polyester
- Dyer contain no heavy metals
- Made of 100% recycled polyester
- Environmentally friendly and controlled for pollutants according to Oeko-Tex® standard 100
- Weight 350 g/m<sup>2</sup>
- Rub resistance 72.000 Martindale/52.500 Wyzenbeek (EN ISO 12947 1 & 2)
- Pilling: Class 4
- Flame resistance to BS 5852 Cigarette burns test
- Lightfastness: > 5 (ISO B02)
- Friction resistance wet: 5, Dry: 5 (EN ISO 105X12)

### Cleaning

- Vacuum regularly
- When dirty, wipe with a damp cloth
- Please follow the care instructions on the label

## Composition Ribcord <sup>2</sup>

- Material: Front 88% polyester, 12% polyamide and the back side 100% polyester
- Dyer contain no heavy metals
- Made of 100% recycled polyester
- Environmentally friendly and controlled for pollutants according to Oeko-Tex® standard 100
- Weight: 386 g/m<sup>2</sup> ± 5%.
- Rub resistance: 100.000 Martindale/75.000 Wyzenbeek (EN ISO 12947 1 & 2)
- Pilling: Class 4-5
- Flame resistance to BS 5852 Cigarette burns test
- Lightfastness: 4-5 (ISO B02)
- Friction resistance we: 5, Dry: 5 (EN ISO 105X12)

### Cleaning

- Vacuum regularly
- When dirty, wipe with a damp cloth
- Please follow the care instructions on the label

## Composition mesh cover S6 <sup>3</sup>

- Material: 100% elastomeric-polyester
- environmentally friendly and inspected for pollutants according to Oeko-Tex® standard 100
- Rub resistance 50.000 Martindale/37.500 Wyzenbeek
- Lightfastness 5
- Friction resistance: Wet: 5, Dry: 4

### Cleaning

- Vacuum regularly
- When dirty, wipe with a damp cloth

## Composition Utensilo fabric <sup>4</sup>

- Material: durable polyester fabric

### Cleaning

- Vacuum regularly
- When dirty, wipe with a damp cloth
- Please follow the care instructions on the label

# Materials

## Desktop design

moll T7

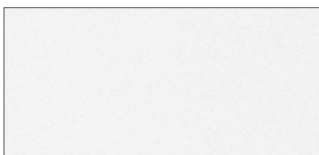

white <sup>1</sup>

moll T5



beige <sup>2</sup>

moll T7 exclusive



oak <sup>3</sup>



walnut <sup>3</sup>

## Panel and drawer design

moll T7 and moll C7



oak <sup>5</sup>

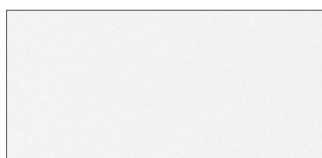

white <sup>4</sup>

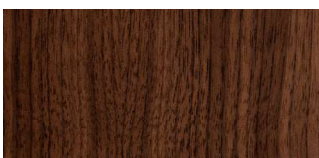

walnut <sup>5</sup>



light blue <sup>4</sup>



lilac <sup>4</sup>

### <sup>1</sup> Melamine resin-coated wood-based panel:

moll wood-based panels are approved according to EN 312 and EN 14322. The formaldehyde class CARB II is complied with, which is based on stricter limit values than the E1 test method according to EN 120. In the case of normal, appropriate and intended use no impairments or damages to health are to be expected according to today's state of knowledge.

### <sup>2</sup> Birch multiplex desktop and panels:

Made from a multiplex board with nano soft-touch coating

### <sup>3</sup> Veneered solid wood panels in oak and walnut:

Veneered particle board with solid end-grain wood edges, sealed with water-based UV varnish.

### <sup>4</sup> MDF wood-based panels coated:

Color pigment and top coat systems: UV-curing water-based coating and therefore particularly environmentally friendly.

### <sup>5</sup> Multi-layer moulded wood parts in oak and walnut:

Molded plywood with oiled solid wood surface.

### Panel edges:

All panel edges are sealed with high-quality ABS edge tape. ABS is a thermoplastic material with excellent material and usage properties. Impact resistant, mechanically and thermally highly resilient, easy to separate and low-emission disposal

# The promise of moll:



## 5 year of guaranteed quality

moll guarantees its customers a five-year warranty when they purchase a moll desk or chair. Everything about the warranty conditions can be found at: [www.moll-funktion.com](http://www.moll-funktion.com)



## 5 years of guarantee availability

moll also offers five years of guaranteed availability only for moll desks - to ensure that additional equipment is available at all times. You can find all guarantee conditions at: [www.moll-funktion.com](http://www.moll-funktion.com)



## AGR

moll products are awarded with the AGR seal of quality. Aktion Gesunder Rücken (AGR) independently awards the seal of approval to products that are ergonomic and at the same time healthy for the back according to medical guidelines.



## Patents

moll develops all fittings themselves. Many of these innovations are protected by industrial property rights or are patent-registered.



## Easy to install

moll attaches the greatest importance to a good organized packing and very good assembly instructions, which are prerequisite for quick and easy assembly.



## Made in Germany

moll products are engineered and manufactured in Germany according to high quality and safety standards.



## Blue Angel:

moll prime furniture is certified according to RAL UZ 38 and bears the "Blue Angel" seal of approval.



## Our responsibility

At moll we use exclusively environmentally friendly materials when manufacturing our desks and chairs. On one hand, we want to keep the CO2 footprint of our products as small as possible. On the other hand, it is very important to us to use materials that can be recycled and reused.



## FSC certification

All wood-based materials used by moll are guaranteeing a responsible handling of the raw material wood. All decorative surfaces are tested for abrasion resistance, stain resistance, scratch resistance, impact resistance and cigarette burns in accordance with EN 14322.



## CARB II

Wood-based materials used by moll are CARB II compliant with stricter limit values than E1 according to test method EN 120. This ensures that in the case of normal, appropriate and intended use no impairments or damages to health are to be expected according to today's state of knowledge.



## PEFC

To ensure the protection of our forests, we purchase our wood only from suppliers with the PEFC seal. This guarantees an ecological and socially acceptable sustainable forestry.



## Electrical Equipment Law

moll products are registered according to the Electrical and Electronic Equipment Regulations. Wholesalers and specialist shops are obliged to take back waste electrical and electronic equipment at no charge when purchasing a new equivalent device.



## Sales department:

Fon: +49 (0) 7335 181-180 / Email: [sales@moll-funktion.de](mailto:sales@moll-funktion.de)

We deliver exclusively according to our general terms and conditions. We reserve the right to make technical changes.  
We assume no liability for errors in content and printing.

moll Funktionsmöbel GmbH, Rechbergstraße 7, D 73344 Gruibingen,  
[info@moll-funktion.de](mailto:info@moll-funktion.de), [www.moll-funktion.com](http://www.moll-funktion.com)  
300240 © Copyright by moll 08/2020

## Follow us on social media:

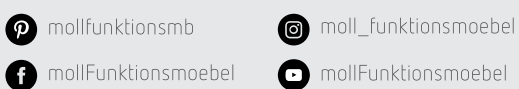

moll Website

